

SWITCHES

TOGGLE SWITCHES



ROCKER SWITCHES



SLIDE SWITCHES



BINARY SWITCHES



KEY SWITCHES



AUDIO SELECTOR SWITCH	2312
BELL PUSH SWITCHES	2312
BINARY ROTARY SWITCHES	2308
DATA ENTRY KEY PAD	2308
DIL SWITCHES	2309
EDGE SWITCHES	2310 - 2311
FOOT SWITCHES	2306
ILLUMINATED TOGGLE SWITCHES	2303
KEY SWITCHES	2309
MAGNETS	2312
MICROSWITCHES	2310
MINATURE PULL SWITCHES	2307
MINATURE PUSH SWITCHES	2305 - 2306
MINATURE TACTILE SWITCHES	2307
MINATURE TOGGLE SWITCHES	2302
MINATURE TOGGLE SWITCH COVERS	2302
MORTICE SWITCH	2312
PCB SWITCHES	2308
REED SWITCHES	2311 - 2312
ROCKER SWITCHES	2303 - 2304
ROTARY SWITCHES	2308
SLIDE SWITCHES	2304 - 2305
STANDARD TOGGLE COVER SWITCHES	2303
STANDARD TOGGLE SWITCHES	2302 - 2303
SUB-MINATURE TOGGLE SWITCHES	2302
SUB-MINATURE PCB TOGGLE SWITCHES	2302
TUMBLER SWITCHES	2303

CON
TENTS

SQUIRES MODEL & CRAFT TOOLS

SUB-MINIATURE PCB TOGGLE SWITCHES

SUB-MINIATURE TOGGLE SWITCHES a range of sub-miniature PCB mounting toggle switches with plain bushes, in either vertical or right angle mounting. The terminals are arranged on a 2.54mm pitch to facilitate mounting. The right angle types also incorporate 2 support pins.



Contact rating 400mA 20V dc
 Contact resistance <20mΩ at 2 - 4Vdc
 Insulation resistance >1000MΩ
 Contact material Copper alloy, gold plate over nickel.
 Operating life 30,000 cycles @ full load.
 Operating temperature -30°C to +85°C

CODE	TYPE	PRICE
820-707	Sub-mini PCB Toggle SPDT - Vertical.....	£1.29
820-709	Sub-mini PCB Toggle DPDT - Vertical.....	£1.69
820-708	Sub-mini PCB Toggle DPDT C/Off - Vertical.....	£1.79
820-710	Sub-mini PCB Toggle SPDT - Right Angle.....	£1.59
820-712	Sub-mini PCB Toggle DPDT - Right Angle.....	£1.89
820-712	Sub-mini PCB Toggle DPDT C/Off - Right Angle.....	£1.99

SUB-MINIATURE TOGGLE SWITCHES

SUB-MINIATURE TOGGLE SWITCHES a range of high quality sub-miniature toggle switches in single pole and double pole options. This range of switches is ideal for use when space is at a premium.



Contact rating 3A, 125V, 1A 250V AC
 Initial contact resistance <20mΩ
 Insulation resistance >100MΩ at 500V DC
 Contact material Copper alloy with silver inlay silver plated
 Body Material Flame retardant alkyd
 Electrical life >2x104 cycles at full load
 Operating temperature -20°C to +60°C

CODE	TYPE	ACTION	PRICE
SMT010	Sub-mini Toggle SPST.....	On-Off.....	£0.80
SMT020	Sub-mini Toggle SPDT.....	On-On.....	£0.85
SMT025	Sub-mini Toggle SPDT C/Off.....	On-Off-On.....	£1.75
821-093	Sub-mini Tog SPDT Biased C/Off.(On)-Off-(On)..		£1.75
SMT030	Sub-mini Toggle DPDT.....	On-On.....	£1.40
821-095	Sub-mini Toggle DPDT C/Off.....	On-Off-On.....	£1.85
821-094	Sub-mini Tog DPDT Biased C/Off.(On)-Off-(On).		£1.99

MINIATURE TOGGLE SWITCH COVERS

COLOURED TOGGLE LEVER COVERS push fit covers for colour coding mini toggle switch levers. 7 colours (Switch not included).



CODE	TYPE	PRICE
MTC110	Mini Toggle Cover Black.....	£0.15
MTC120	Mini Toggle Cover White.....	£0.15
MTC130	Mini Toggle Cover Red.....	£0.15
MTC140	Mini Toggle Cover Blue.....	£0.15
MTC150	Mini Toggle Cover Green.....	£0.15
MTC160	Mini Toggle Cover Yellow.....	£0.15
MTC170	Mini Toggle Cover Grey.....	£0.15

MINIATURE TOGGLE SWITCHES

MINIATURE TOGGLE SWITCHES a wide range of high quality miniature toggle switches in single pole and double pole options and with momentary biased action. **For biased switching action (On) indicates momentary action.**



Contact rating 6A, 125V, 3A 250V AC
 Initial contact resistance <20mΩ
 Insulation resistance >100MΩ at 500V DC
 Contact material Copper alloy with silver inlay silver plated
 Body material Flame retardant alkyd
 Electrical life >5x104 cycles at full load
 Operating temperature -20°C to +65°C

CODE	TYPE	ACTION	PRICE
MT0040	Mini Toggle SPST.....	On-Off.....	£0.75
MT0050	Mini Toggle SPDT.....	On-On.....	£0.80
MT0060	Mini Toggle SPDT C/Off.....	On-Off-On.....	£0.85
MTB062	M/Toggle SPDT Biased One Side....	On-Off-(On)....	£1.35
MT0070	Mini Toggle DPDT.....	On-On.....	£1.00
820-071	Mini Toggle DPDT.....	On-(On).....	£1.90
MT0080	Mini Toggle DPDT C/Off.....	On-Off-On.....	£1.25
MTB082	M/Toggle DPDT Biased One Side....	On-Off-(On)....	£1.99
MTB090	Mini Toggle SPDT Biased C/Off....(On)-Off-(On).		£1.50
MTB100	Mini Toggle DPDT Biased C/Off....(On)-Off-(On).		£1.75

*** The Biased Off switches MTB090 and MTB100 are ideal for operating solenoids including point motors etc. ***

3 POLE AND 4 POLE MINIATURE TOGGLE SWITCHES a range of high quality miniature toggle switches in 3 pole and 4 pole.

Rated 6A @ 125Vac,
 3A @ 250Vac.



Type Dims (mm)
 3PDT 13x18x11
 4PDT 13x23x11
 4PDT C/O 13x23x11

CODE	TYPE	ACTION	PRICE
MT0125	Mini Toggle 3PDT C/Off.....	On-Off-On.....	£2.89
MT0135	Mini Toggle 4PDT.....	On-On.....	£2.79
MT0145	Mini Toggle 4PDT C/Off.....	On-Off-On.....	£2.99

STANDARD TOGGLE SWITCHES

STANDARD TOGGLE SWITCHES standard size toggle switches with solder tag terminals, supplied with On/Off plate. Single pole and double pole options are available.

Rated 1.5A 250V ac.
 Body dimensions:-
 single pole 25 x 14 x 14mm,
 double pole 28 x 18 x 14mm.



CODE	TYPE	PRICE
STT180	Standard Toggle SPST On-Off.....	£0.85
STT190	Standard Toggle DPDT On-On.....	£0.99

HIGH CURRENT STANDARD TOGGLE SWITCH a high quality standard toggle switch with DPDT centre off action. The switch has screw terminals and a On/Off/On plate. Body dimensions:- 35 x 19 x 19mm. 12mm panel cutout. Rating 6A 250V ac, 10A 125V ac.



CODE	TYPE	PRICE
STT200	Standard Toggle DPDT C/Off On-Off-On.....	£2.99

SQUIRES ELECTRONIC COMPONENTS

HIGH CURRENT TOGGLE SWITCHES a range of high current switches for tough applications. Screw connections. Supplied with 2 fixing nuts and washer. Sold individually.

Technical Specification

Rating 250 Vac /
10A, (15A DC)
Switch life >50,000 cycle



CODE	TYPE	PRICE
821-006	High Current Std Tog Switch SPST On-Off.....	£1.35
821-008	High Current Std Tog Switch SPDT On-On.....	£1.45
821-010	High Current Std Tog Switch SPDT On-Off-On....	£1.50
821-012	High Current Std Tog Switch DPDT On-On.....	£1.65
821-014	High Current Std Tog Switch DPDT On-Off-On...	£1.99

HIGH CURRENT STANDARD TOGGLE SWITCHES a range of high quality high current standard toggle switches. Panel cut out 12mm. Rated at 250V AC 10A. 6.3mm solder tag termination.

Dimensions:-
SPST - 30 x 18 x 14mm
DPDT - 30 x 21 x 20mm



CODE	TYPE	PRICE
820-927	High Current Std Toggle SPST On-Off.....	£2.25
820-929	High Current Std Toggle DPDT On-On.....	£2.99

MISSILE STYLE TOGGLE SWITCH COVER a military style missile switch cover with a red heavy duty spring return protective cover. Suitable for use with most standard toggle switches with a 12mm mounting hole.



CODE	TYPE	PRICE
820-042	Missile Style Toggle Switch Cover.....	£3.99

STANDARD TOGGLE SWITCH COVER

TOGGLE SWITCH COVER a flexible cover boot for standard size toggle switches, giving protection against dirt and liquid ingress. The boot has a rubberised actuator cover with a plastic knurled skirt containing a brass nut with thread to suit standard toggle switches. Supplied complete with mounting washer. Height above panel when mounted; approx 25mm. Skirt diameter 20mm.



CODE	TYPE	PRICE
820-500	Standard Toggle Switch Cover.....	£0.99

ILLUMINATED TOGGLE SWITCHES

ILLUMINATED TOGGLE SWITCH a SPST toggle switch where the toggle is illuminated when the switch is in the on position. The switch is rated 20A, 12Vdc. Body dimensions 24.4 x 14 x 14mm, bush length M12 x 11mm long, panel cutout 12mm. Available in 3 colours.



CODE	TYPE	PRICE
820-029	Illuminated Toggle Switch SPST On/Off Red.....	£2.19
820-030	Illuminated Toggle Switch SPST On/Off Green....	£2.19
820-032	Illuminated Toggle Switch SPST On/Off Amber...	£2.19

TUMBLER SWITCH

MINIATURE TUMBLER SWITCH a miniature surface mounting SPST (On-Off) toggle switch, that is often referred to as a dolls house switch. Fully chromed actuator and cover. Connection is made via screw terminals. To be used for low voltages only 12V 3A max.



CODE	TYPE	PRICE
MTS123	Miniature Tumbler Switch On-Off.....	£1.65

ROCKER SWITCHES

ROCKER SWITCH a SPST **ROCKER SWITCH** a SPDT rocker switch rated at 250 Vac/6A. Silver plated solder tags also accept 4.8mm push on terminals. Push fitting. Mounting hole 13 x 20mm.



CODE	TYPE	PRICE
821-034	Rocker Switch SPDT On-On Black.....	£0.59

SPST MINIATURE ROCKER SWITCH a miniature single pole rocker switch with black concave rocker which has a red marking which is clearly visible when switch is in the on position. Switch snap fits into a 20mm panel cut-out. 4.8 x 0.8mm fast on connections

Technical Specification

Contact rating 6A 250V AC
10A 125V AC
Initial contact resistance <50mΩ
Insulation resistance 100M at 500V DC
Termination 4.8 x 0.8mm fast on
Operating temperature -20° to +65°C



CODE	TYPE	PRICE
820-931	Miniature Rocker Switch SPST On-Off.....	£1.30

MINIATURE ROCKER SWITCH DPST a miniature rocker switch with double pole single throw action in a compact package. The on position is clearly marked on the rocker face. Contacts rated:- 4A 250V ac, 8A 125V ac. Panel cut-out 19.2 x 13.2mm.



CODE	TYPE	PRICE
RS0270	Miniature Rocker Switch DPST On-Off.....	£1.85

MINIATURE VISIBLE ON ROCKER SWITCH a range of single pole rocker switches with red, green or blue marking on the rocker which is clearly visible when the switch is in the 'on' position. 4.8 x 0.8mm connections. Panel cutout 19.2 x 13mm. A waterproof cover for the switch is also available see 820-939.

Technical Specification

Contact rating 6A 250V
10A 125V
Initial contact resistance <50mΩ
Insulation resistance >100M @ 500V dc
Termination 4.8 x 0.8mm fast on
Operating temperature -20° to +65°C



CODE	TYPE	PRICE
820-933	Min Visible On Rocker Swth SPST On-Off Red..	£ 1.19
820-935	Min Visible On Rocker Swth SPST On-Off Green	£1.19
820-937	Min Visible On Rocker Swth SPST On-Off Blue...	£1.19

SQUIRES MODEL & CRAFT TOOLS

WATERPROOF SWITCH COVER a clear waterproof switch cover which fits on the visible on range of rocker switches. Cover simply clips over the front of the switch and switch on/off status can be clearly seen through the transparent cover. **Switch not included.**



CODE	TYPE	PRICE
820-939	Waterproof Switch Cover.....	£0.35

MINIATURE ILLUMINATED ROCKER SWITCH a miniature double pole rocker switch incorporating a neon and series resistor providing clear power on indication during 240V ac operation. Panel cut-out 19.2 x 13.2mm.

Contacts rated:-
4A 250V ac.
8A 125V ac.



CODE	TYPE	PRICE
RSI300	Mini Illuminated Rocker Red DPST On-Off.....	£1.89
RSI305	Mini Illuminated Rocker Green DPST On-Off.....	£1.89

STANDARD ILLUMINATED ROCKER SWITCH quality rocker switches of modern ergonomic appearance. Matt black bezel with red rocker. Fitted with a neon and resistor giving clear 'on' indication during 240V ac operation.

Panel cut-out
SPST 30 x 10.8mm
DPST 30 x 22mm.
Contact rating:-
10A 250V ac,
16A 125V ac.



CODE	TYPE	PRICE
RSI295	Illuminated STD Rocker Red SPST On-Off.....	£1.79
RSI280	Illuminated STD Rocker Red DPST On-Off.....	£2.35

HIGH CURRENT ROCKER SWITCH a high current neon rocker switch for in car use. 6-12V. 12Vdc/ 30A max contact rating. Connectors for 6.3mm terminals.



CODE	TYPE	PRICE
821-046	High Current Rocker Switch SPST On-Off.....	£1.99

ROCKER SWITCH SPDT this low cost rocker switch incorporates an all nylon body with snap-in mounting. It has silver plated brass terminals, available with red and green buttons and is easy to install. 27.6 x 13.8mm panel cut-out. Dimensions 19(L) x 8(W)mm. UL flame 94V-2 approved

Technical Specification

Voltage rating: 16A 125V AC / 10A 250V AC
Contact resistance: 50mΩ max.
Contact points: Silver alloy
Insulation resistance: 500V DC, 100MΩ min.
Dielectric strength: 1500V AC, 1 minute
Circuit: 3PDT
Mount hole: 27.6mm x 13.8mm
Panel thickness: 4mm



CODE	TYPE	PRICE
30-0078	Rocker Switch SPDT Double Push Red/Green....	£1.89

SLIDE SWITCHES

MINIATURE LOW POWER PCB SLIDE SWITCH SPDT a miniature SPDT slide switch. For PCB mounting and suitable for many signal switching applications. Nylon 66, UL 94V-0 approved.

Technical Specification

Contact rating: 12V DC, 0.5A
Contact resistance: 30MΩ max.
Mechanical life: 1000 cycles
Insulation resistance: 500mΩ min. @ 500V DC
Switch function: On - Off - On
Contact material: Gold plated brass



CODE	TYPE	PRICE
30-0092	Mini L/Power PCB Slide Switch SPDT.....	£1.25

MINIATURE VERTICAL PCB SLIDE SWITCH SPDT a low-cost SPDT miniature slide switch for PCB mounting with a long lifespan. Silver plated solder terminals and a pitch of 4mm. Rating 0.5A 50V DC.



CODE	TYPE	PRICE
30-0084	Miniature Vertical PCB Slide Switch SPD.....	£0.30

ULTRA MINIATURE PCB SLIDE SWITCH SPDT a miniature slide switch with SPDT contacts. The body measures just 8.5 x 3.5 x 3.5mm and is ideally suited to a wide range of low voltage applications. It has right angle actuator button making it ideal for edge of board applications. The pins are on a 2.54mm pitch making the switch suitable as an alternative to jumpers etc. Contacts are rated 0.3A at 6V.



CODE	TYPE	PRICE
30-0086	Ultra Miniature PCB Slide Switch SPDT.....	£0.45

ULTRA-MINIATURE SLIDE SWITCH measuring only 8.5 x 3.5mm, this SPDT right angle switch is ideal for applications in miniature equipment such as headphones, LCD TV's, radios, VCRs etc. Pins are on a 2.54mm pitch making this switch a viable alternative to pins and jumpers on PCBs. Contact rating 30V DC, 0.2A.

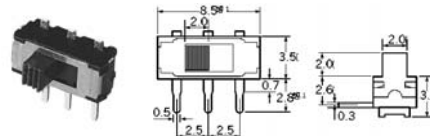

CODE	TYPE	PRICE
820-502	Miniature Slide Switch SPDT On-On.....	£0.45

{MINIATURE PCB SLIDE SWITCHES Miniature SPDT PCB mounting slide switches available in vertical or right angle options. Suited to many signal switching applications both switches incorporate PCB supports to improve rigidity. Non shorting contacts rated at 0.3A 125V AC.

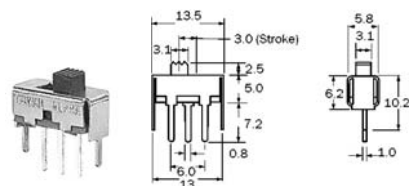

CODE	TYPE	PRICE
820-504	Miniature Vertical SPDT Slide Switch.....	£0.50
820-505	Miniature Right Angle SPDT Slide Switch.....	£0.50

SQUIRES ELECTRONIC COMPONENTS

MINIATURE PCB SLIDE SWITCHES SPDT a range of miniature slide switches available with different size actuators. The choice of actuator size is 2mm or 4.4mm. Rated at 0.3A 6V DC with a pitch of 2.5mm. SPDT circuit.



CODE	TYPE	PRICE
30-0088	Mini PCB Slide Switch SPDT 2mm Actuator.....	£0.45
30-0090	Mini PCB Slide Switch SPDT 4.4mm Actuator.....	£0.49

MINIATURE SLIDE SWITCH a miniature slide switch with solder tag connections with break before make DPDT contacts. Contacts rated 0.3A 125V ac.

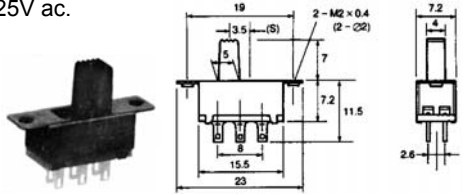

CODE	TYPE	PRICE
SLS400	Miniature Slide Switch DPDT On-On.....	£0.30

STANDARD SLIDE SWITCHES with solder tag connections, break before make DPDT contacts, and also with centre off. Contacts rating 0.3A 125V ac.

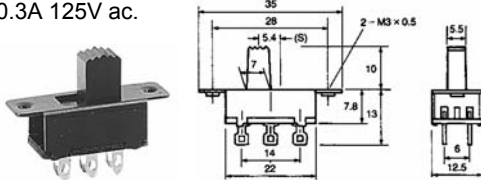

CODE	TYPE	PRICE
SLS410	Standard Slide Switch DPDT On-On.....	£0.30
SLS420	Standard Slide Switch DPDT C/Off On-Off-On....	£0.35

MINIATURE PUSH SWITCHES

MINIATURE PUSH TO MAKE SWITCHES miniature low cost push to make switches offered in a variety of colours. Non-locking momentary action - biased to OFF, ideal for operation of solenoids etc.

Rated 250V ac 0.5A.
Panel cutout 7mm.

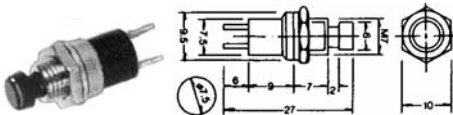

CODE	TYPE	PRICE
PTM190	Push to Make Red Off-(On).....	£0.30
PTM200	Push to Make Black Off-(On).....	£0.30
PTM210	Push to Make Green Off-(On).....	£0.30
PTM220	Push to Make Yellow Off-(On).....	£0.30
PTM230	Push to Make Blue Off-(On).....	£0.30
PTM240	Push to Make White Off-(On).....	£0.30

* PURCHASE ANY QUANTITY OF 10 OR MORE PUSH TO MAKE SWITCHES IN ANY COMBINATION OF COLOURS FOR £0.25 EACH SWITCH *

MINIATURE PUSH TO BREAK SWITCH a range of miniature low cost switches with opposite action to push to make action. Dims as above.



CODE	TYPE	PRICE
PTB260	Push to Break Black On-(Off).....	£0.45
821-056	Push to Break Red On-(Off).....	£0.45
821-060	Push to Break Green On-(Off).....	£0.45
821-062	Push to Break Blue On-(Off).....	£0.45
821-064	Push to Break Yellow On-(Off).....	£0.45
821-066	Push to Break White On-(Off).....	£0.45

MINIATURE MOMENTARY ACTION PUSH SWITCH these low cost push to make switches come with an all-plastic body and chrome locking nut, with a non-locking momentary action. Available with a red or black button for a 5.2mm (M5) diameter panel cut-out with silver plated brass terminals. Dimensions 19(L) x 8mm diameter. UL 94V-2 approved.



Technical Specification

Voltage rating:	0.5A 125V AC
Contact resistance:	50mΩ max.
Insulation resistance:	500V DC, 100MΩ min.
Dielectric strength:	1000V AC, 1 minute
Circuit:	SPST momentary push to make
Mount hole:	5.2mm
Panel thickness:	4mm max.

CODE	TYPE	PRICE
30-0014	Mini Momentary Push Switch Small Button Red..	£0.79
30-0016	Mini Momentary Push Switch Small Button Black	£0.79

LOW PROFILE PUSH SWITCHES a range of low profile push switches with large 9mm actuator button available in momentary action push to make, push to break or changeover options. Smart chrome bezel with button. Supplied in red or black.



Technical Specification

Contact rating	3A 125V AC 1.5A 250V AC
Contact resistance	50mΩ max.
Insulation resistance	>10 x 10 ⁷ Ω min
Body dimensions push to make	20mm x 14.0mm dia
push to break	22.3mm x 14.0mm dia
SPDT	21mm x 14.0mm dia
Panel cut out	12.7mm

CODE	TYPE	PRICE
820-941	L/Profile Push To Make Red Switch Off-(On).....	£1.55
820-943	L/Profile Push To Break Black Switch On-(Off)....	£1.75
820-945	L/Profile S/Pole Changeover Red Switch On-On.	£1.99

SQUARE PUSH SWITCHES a range of attractive but robust large button push switches with red and black actuator buttons, available in non-locking push to make or SPST latching action. Body dims:- 34 x 15 x 15mm. Panel cutout:- 12mm. Contacts rated 3A 250V ac



CODE	TYPE	PRICE
PTM262	Square Push to Make Red Off-(On).....	£0.90
PTM265	Square Push to Make Black Off-(On).....	£0.90
SLS290	Latching Switch SP Red On/Off.....	£1.05
SLS300	Latching Switch SP Black On/Off.....	£1.05

MINIATURE LATCHING PUSH SWITCH a low-cost, panel mounting, latching 2P SPST push switches that have small buttons. Available with red or black buttons and fits into 7mm panel cut-out, max. thickness 4mm. With silver plated brass solder terminals. Nylon frame to UL 94V-2.



Technical Specification

Rating:	250V AC 1.5A/125V AC 3A
Contact resistance:	50mΩ max.
Insulation resistance:	100MΩ min.
Dielectric strength:	1500V AC 1 minute

CODE	TYPE	PRICE
30-0018	Mini Latching Push Switch Small Button Red.....	£1.19
30-0020	Mini Latching Push Switch Small Button Black....	£1.19

SQUIRES MODEL & CRAFT TOOLS

MINIATURE LATCHING PUSH SWITCH SPST a low-cost, panel mounting, latching 2P SPST push switch that has large buttons. It fits into a 7mm panel cut-out, maximum thickness 4mm, available with red or black button and it has silver plated brass solder terminals. Nylon frame to UL 94V-2.

Technical Specification

Rating 250V AC 1.5A/125V AC 3A
 Contact resistance 50mΩ max.
 Insulation resistance 100MΩ min.
 Dielectric strength 1500V AC 1 minute



CODE	TYPE	PRICE
30-0098	Mini Latching Switch Large Button SPST Red.....	£1.25

MINIATURE LATCHING PUSH SWITCH WITH LED a miniature low cost push to make switch with an all-plastic body and a latching action. Available with a red LED actuating button and silver plated brass terminals. Easy to install into panel and snap-fits into a 9.3mm dia. panel cut-out. Dimensions 25(L) x 11mm diameter. UL flame 94HB approved.

Technical Specification

Voltage rating: 1A 125V AC/0.5A 250V AC
 Contact resistance: 50mΩ max.
 Insulation resistance: 500V DC, 100MΩ min.
 Dielectric strength: 1000V AC, 1 minute
 Circuit: SPST latching push to make (illuminated)
 Mount hole: 9.3mm
 Panel thickness: 0.5 to 2mm
 LED VF min.: 1.7V
 LED VF typ.: 2.0V
 LED VF max.: 2.6V
 LED IF: 20mA



CODE	TYPE	PRICE
30-0026	Mini Latching Push Switch Red LED SPST.....	£1.79

LATCHING SWITCHES round push button switches with latching action, open/closed contact and solder tags. Rating 250 Vac / 1A, (3A DC).



CODE	TYPE	PRICE
821-026	Latching Push On/Push Off Switch Red.....	£0.90

MINIATURE PUSH SWITCH a miniature SPDT changeover switch with locking push button action with solder tag terminals. Body dims:- length 13mm, width 8.2mm, height 17.5mm. Button diameter 10mm. Rated 1A 250Vac.



CODE	TYPE	PRICE
820-091	Miniature Push Switch Push On/Push On.....	£2.65

CIRCULAR PUSH-PULL SWITCH SPST a SPST push-pull panel mounted switch that has an LED in the knob that is lit when the switch is in the 'On' position. It is durable, does not generate heat and has stable brightness. Available with small (22mm dia.) or large (28mm dia.) knob and is secured by a nut. Panel cut-out diameter 12.2mm. Contact rating is 12V DC 10A. 6.3mm quick connect terminals. SCI A3-30 series.



CODE	TYPE	PRICE
30-0028	Push/Pull Switch SPST Red LED.....	£2.65
30-0030	Push/Pull Switch SPST Green LED.....	£2.65

TABLE LIGHT SWITCH a single pole push-on push-off switch, white push button. Panel cutout 10mm, maximum panel thickness 4mm. Body dims:- 24 x 13 x 8.5mm. Rated 2A at 250V ac.



CODE	TYPE	PRICE
TLS330	Table Light Switch On-Off.....	£1.60

FOOT SWITCHES

FOOT SWITCH a heavy duty foot switch with push to make momentary action. Rated at 250Vac/3A. M12 thread of 16mm length and 2 nuts. Large solder tags.



CODE	TYPE	PRICE
821-030	Heavy Duty Foot Switch Push to Make Off-(On)..	£2.69

FOOT SWITCHES DPDT a rugged switch with heavy-duty actuator buttons designed for operation by foot. It is ideal for foot pedals in music applications and for use in machinery control leaving hands free. Momentary or latching models and DPDT contacts.

Technical Specification

Rating: AC 125V, 6A AC 250V, 3A DC 30V, 4A
 Contact material: Silver
 Contact resistance: 50mΩ max.
 Insulation resistance: DC 500V, 100MΩ min.
 Withstand voltage: AC 1000V for 1 minute
 Operating force: 1.2±0.3kgf
 Travel: 2.7mm
 Overall dimensions: 13.4 x 12 x 37mm
 Depth behind panel: 28.5mm
 Fixing thread: 12mm dia. x 0.75mm pitch
 Life expectancy: 30,000 cycles



CODE	TYPE	PRICE
30-0094	Foot Switch DPDT Momentary Action.....	£3.39
30-0096	Foot Switch DPDT Latching.....	£3.39

FOOT SWITCH a robust momentary action foot operated switch with non slip base. Supplied with 1.7m lead terminated to a 2.5mm jack plug. Dimensions 74 x 75 x 32mm. Rated 60V MAXIMUM 1A.



CODE	TYPE	PRICE
820-947	Foot Switch.....	£5.99

IN-LINE FOOT SWITCH an in-line push on/push off foot switch as used on lamps etc, useful for similar applications. Maximum rating 2 amps, 250Vac. Available in white or black.



CODE	TYPE	PRICE
820-146	In-Line Foot Switch Push On/Push Off White.....	£3.99
820-147	In-Line Foot Switch Push On/Push Off Black.....	£3.99

SQUIRES ELECTRONIC COMPONENTS

MINIATURE PULL SWITCHES

MINIATURE PULL SWITCH a miniature pull on/pull off switch with centre pull cord and two fixing holes. Maximum rating 2 amps, 250Vac. Body dimensions:- 23 x 13 x 8mm.



CODE	TYPE	PRICE
820-242	Miniature Pull Switch On/Off Centre Cord.....	£1.69

MINIATURE PULL SWITCH a miniature pull on/pull off switch with side pull cord with one fixing hole. Maximum rating 2 amps 250Vac. Body dimensions 26 x 15 x 11mm.



CODE	TYPE	PRICE
820-544	Miniature Pull Switch On/Off Side Cord.....	£1.49

MINIATURE TACTILE SWITCHES

MINIATURE RECTANGULAR TACTILE SWITCH a miniature rectangular tactile switch measuring only 6 x 3.5mm. The switch has a good positive action and normally open contacts and a life expectancy of at least 50,000 operations.



Technical specification

Contact rating	12V DC 50mA
Travel	0.25mm
Operating force	180 ± 30gf
Contact resistance	100mΩ max.
Life	50,000 cycles min

CODE	TYPE	PRICE
820-949	Miniature Rectangular Tactile Switch.....	£0.31

MINIATURE TACTILE SWITCHES a range of miniature 6 x 6mm PCB mounted tactile switches offering a positive switching action through a unique dome construction. Single pole normally open contacts, available with flat or projected plunger.

Contact rating	50mA 12V dc
Initial contact resistance	<100mΩ
Insulation resistance	>100mΩ at 100V DC
Dielectric strength	250V ac for 1 minute
Travel	0.25 ± 0.1mm
Operating life	10 x 10 ⁴ minimum operations
Operating temperature	-20°C to +70°C



CODE	TYPE	L	PRICE
820-480	Tactile Switch Flat Button	4.3mm.....	£0.45
820-485	Tactile Switch Projected Button	5.0mm.....	£0.45
820-490	Tactile Switch Projected Button	7.0mm.....	£0.45
820-495	Tactile Switch Projected Button	9.5mm.....	£0.45

RIGHT ANGLE 6 X 6MM TACTILE SWITCH right angle miniature PCB mounting tactile switches with a choice of button lengths.

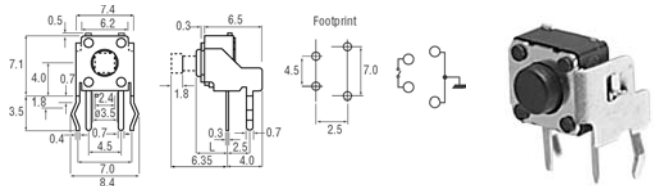

Technical Specification

Contact rating	50mA, 12V dc
Initial contact resistance	<100mΩ max
Operating force	100+50gf
Travel	0.25mm
Insulation resistance	100MΩ min
Life expectancy	500,000 operations(electrical)
Operating temperature range	-25 to +70°C

CODE	TYPE	PRICE
820-956	Right Angle Tactile Switch 3.85mm Length.....	£0.45
820-958	Right Angle Tactile Switch 5.85mm Length.....	£0.45

SQUARE BUTTON 6X6MM TACTILE SWITCH a miniature PCB mounting 6x6mm tactile switch with a square button shoulder designed to accommodate actuator springs for tamper switch applications. A range of coloured buttons are also available to suit the switch. Single pole normally open contacts.

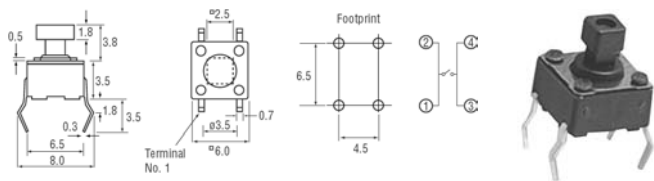

Technical Specification

Contact rating	50mA 12V dc
Initial contact resistance	<100MΩ max
Operating force	100 - 50gf
Travel	0.25mm
Life expectancy	500,000 cycles min
Operating temperature range	-25 to +70°C

CODE	TYPE	PRICE
820-960	Square Button 6 x 6mm Tactile Switch.....	£0.45

BUTTONS FOR TACTILE SWITCHES A range of either square or round buttons for use with the 6x6mm tactile switches fitted with square buttons (not suitable for round head switches). Dimensions round 4.5mm dia x 5.5mm, square 4mm square x 5.5mm.

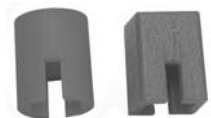

CODE	TYPE	PRICE
820-962	Round Button For Tactile Switch Black.....	£0.12
820-964	Round Button For Tactile Switch Red.....	£0.12
820-966	Square Button For Tactile Switch Black.....	£0.12
820-968	Square Button For Tactile Switch Red.....	£0.12

**SEE ALSO
THE SENSORS SECTION
FOR MOVEMENT SENSORS
AND SWITCHES**

SQUIRES MODEL & CRAFT TOOLS

PCB SWITCHES

STANDARD INTERLOCKING PCB SWITCHES a range of high quality PCB mounting switches which may be easily adjusted to momentary or latching action as required. A maximum of 10 switches may be banked together. The polycarbonate housing has PCB pins fixed on top face and solder terminals on underside.

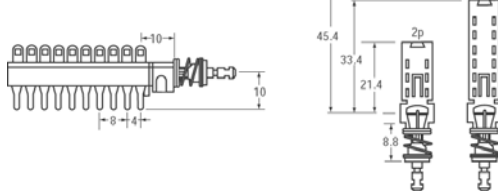

Technical Specification

Contact rating	0.5A 100VAC 0.2A 250VAC 1A 25V
Insulation resistance	2 x 10 ¹² Ω minimum
Operating force	2 pole changeover 600g + 100g 4 pole changeover 600g + 100g 6 pole changeover 600g + 200g
Action	break before make
Electrical life	1 x 10 ⁵ operations
Temperature range	-10° to +60°C

CODE	TYPE	PRICE
820-951	Std Interlock PCB Switch 2 Pole Changeover....	£0.89
820-953	Std Interlock PCB Switch 4 Pole Changeover....	£1.89
820-954	Std Interlock PCB Switch 6 Pole Changeover....	£1.99

PCB POWER SWITCH a PCB mounting double pole single throw mains power push switch. Supplied with a mounting bracket with 2 x M3 tapped screw holes on 20mm centres. Suitable knob listed below. Approvals; UL, CSA, BSI, VDE, MEMKO, DEMKO and EI.



Contact rating	5A 250V ac (8A surge)
Actuator pressure	450gf
Actuator travel	4mm
Electrical life	>10 x 10 ⁴ operations minimum
Operating temperature	-20°C to +70°C

CODE	TYPE	PRICE
820-600	PCB Power Switch DPST.....	£3.99
820-605	Knob for PCB Power Switch.....	£0.36

DATA ENTRY KEY PAD

DATA ENTRY KEYPAD A low profile 3 x 4 keypad of compact size suitable for use on hand held and other small equipment. A single rectangular cut is required to fit the keypad through the front panel and four mounting holes are required for the retention of the keypad. The conductive rubber contacts require a low operating force, but have a positive action to give the operator feedback. Connections are terminated to solder pads on the PCB at the lower edge of the switch. Supplied in matrixed format.

Technical specifications	
Contact rating	20mA, 24V DC max.
Contact bounce	Less than 10ms
Contact resistance	Less than 200Ω
Mechanical life	>1 x 10 ⁶ operations
Operating temperature	-20° to +60 °C



CODE	TYPE	PRICE
820-925	Data Entry Keypad.....	£4.99

ROTARY SWITCHES

ROTARY SWITCHES a range of standard pattern skeleton type rotary switches. Make before break action. Metal shaft, shaft diameter 6mm, length 43mm. Rating 125V ac 250mA.



CODE	TYPE	PRICE
RSW340	Rotary Switch 1P 12 Way.....	£1.79
RSW350	Rotary Switch 2P 6 Way.....	£1.79
RSW360	Rotary Switch 3P 4 Way.....	£1.79
RSW370	Rotary Switch 4P 3 Way.....	£1.79

ROTARY SWITCHES a range of standard pattern fully enclosed rotary switches. Make before break action. Shaft 6.35mm dia x 43mm. Rating 250V ac, 125mA.



CODE	TYPE	PRICE
RSW372	Rotary Switch 1p 12 Way.....	£1.79
RSW373	Rotary Switch 2P 6 Way.....	£1.79
RSW374	Rotary Switch 3P 4 Way.....	£1.79
RSW375	Rotary Switch 4P 3 Way.....	£1.79

PCB MOUNTING ROTARY SWITCHES A range of quality rotary switches in glass filled nylon. Make before break contact. Positive index feel is obtained by employing a dual spring plunger mechanism. Adjustable stop facility.



Technical Specification

Contact rating	150mA 250V AC
Initial contact resistance	20mΩ max
Contact material	Silver plated brass
Electrical life	15 x 10 ³ full rotation cycles
Temperature range	-20° to +65°C

CODE	TYPE	PRICE
820-970	PCB Mounting Rotary Switch 1 Pole 12 Way.....	£1.79
820-972	PCB Mounting Rotary Switch 2 Pole 6 Way.....	£1.79
820-974	PCB Mounting Rotary Switch 3 Pole 4 Way.....	£1.79
820-976	PCB Mounting Rotary Switch 4 Pole 3 Way.....	£1.79

BINARY ROTARY SWITCHES

BINARY CODED ROTARY SWITCH a miniature PCB mounting binary coded rotary switch with gold plated contacts. Available in horizontal mounting with either 16 position hexadecimal (0-9, A-F) or 10 position decimal outputs. Both types have a recessed arrow position indicator which can be operated by a screwdriver.

Technical Specification

Dimensions:	10 x 10 x 4.7mm
Pitch:	2.54mm
Contacts:	100mA 5V DC (resistive)
Contact resistance:	Less than 100mΩ
Operating life:	10,000 min.
Temperature range:	-25°C to +70°C



CODE	TYPE	PRICE
30-0080	Binary Rotary Switch Hexadecimal.....	£3.20
30-0082	Binary Rotary Switch Decimal.....	£3.20

SQUIRES ELECTRONIC COMPONENTS

KEY SWITCHES

KEY SWITCH single pole make/break key operated switches. The key may be removed in either the 'On' or 'Off' position. The switch body and bezel is plated. The key is a common key type, supplied with 2 keys. Contact rating 1.5A 125V ac.



CODE	TYPE	PRICE
KSW436	Key Switch SPST Common Key.....	£6.99

MINIATURE KEY SWITCHES single pole make/break key operated switches. The round profile key may be removed in either the 'On' or 'Off' position. The switch body is brass and has a chrome plated bezel. The switch is available as either a random selection, (maximum selection 100 types) or common key types. Supplied with 2 keys. Contact rating 1A 250V ac.

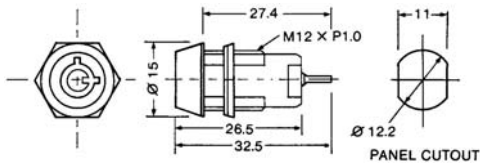

CODE	TYPE	PRICE
KSW295	Mini Key Switch SPST Common Key.....	£4.99
KSW300	Mini Key Switch SPST Random Key.....	£5.49

STANDARD KEY SWITCH a single pole double throw key switch. The round profile key is used for added security and may be removed in either the 'On' or 'Off' position. The switch body is brass and has a chrome plated bezel. Supplied with 2 keys. Contact rating 2A 250V ac.

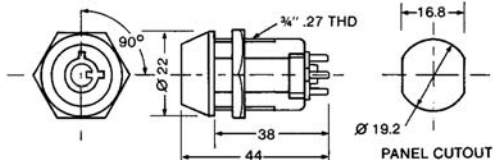

CODE	TYPE	PRICE
KSW305	Standard Key Switch SPDT.....	£5.99

DIL SWITCHES

DIL SWITCHES a range of dual in line laterally operated switches designed to be end stacked with gold plated SPST contacts housed in blue moulded bodies, flame retardant to UL94V-0 with sealed bases to prevent flux contamination. On/off status is clearly defined on the switch. Ideally suited for multiple programming functions ie computers, communications equipment, remote control etc.

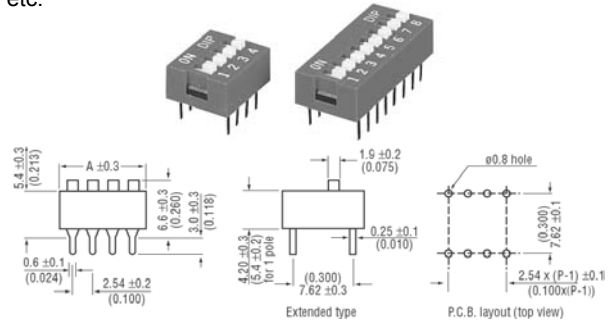

Technical Specification

Contact rating	switching	25mA 24V dc
	non switching	100mA 50V dc
Contact resistance		50mΩ initial
		100mΩ (after life test)
Operating force		800g max
Capacitance		5pF max between contacts
Mechanical life		>2000 operations
Contact material		phosphor bronze with gold plating 5 micron over nickel
Operating temperature range		-25° to 70°C

CODE	TYPE	PRICE
820-978	DIL Switch 2 Way 4 Pin.....	£0.85
820-980	DIL Switch 3 Way 6 Pin.....	£0.90
820-982	DIL Switch 4 Way 8 Pin.....	£0.95
820-984	DIL Switch 5 Way 10 Pin.....	£1.05
820-986	DIL Switch 6 Way 12 Pin.....	£1.10
820-990	DIL Switch 8 Way 16 Pin.....	£1.22
820-992	DIL Switch 9 Way 18 Pin.....	£1.29
820-994	DIL Switch 10 Way 20 Pin.....	£1.49
820-996	DIL Switch 12 Way 24 Pin.....	£1.69

PIANO KEY DIL SWITCHES A range of dual in line piano key switches with gold plated SPST contacts housed in blue moulded bodies, flame retardant to UL94V-0, with sealed bases to prevent flux contamination. On/off status is clearly defined on the switch (actuator down = On). Ideally suited to multiple programming functions ie computer, communications equipment, remote control, security etc.

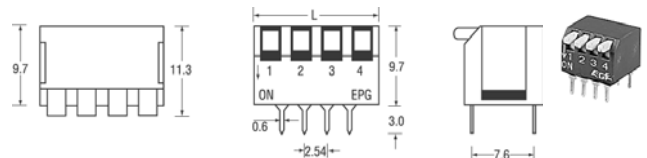

Technical Specification

Contact rating	switching	25mA 24V DC
	non switching	100mA 50V DC
Contact resistance		50mΩ initial
		100mΩ (after life test)
Operating force		800g max
Life expectancy		>3000 operations per pole
Contact material		phosphor bronze with gold plating 5 micron over nickel
Operating temperature		-25° to +70°C

CODE	TYPE	PRICE
820-998	Piano Key DIL Switch 4 Way 8 Pin L 11.7.....	£1.35
821-000	Piano Key DIL Switch 6 Way 12 Pin L 16.7.....	£1.60
821-002	Piano Key DIL Switch 8 Way 16 Pin L 21.7.....	£1.80

PRODUCT CODES

**PLEASE NOTE
IT IS VERY IMPORTANT TO USE
THE CORRECT PRODUCT CODE
FOR THE ITEMS YOU
WISH TO ORDER**

**IT IS VITAL TO INCLUDE
THE PUNCTUATION IN THE CODE
AND TO FORMAT THE CODE
AS SHOWN IN THE CATALOGUE**

SQUIRES MODEL & CRAFT TOOLS

MICROSWITCHES

SUB-MINIATURE MICROSWITCHES a range of new generation sub-miniature microswitches which offer a 1A 250V ac switching ability in a miniature package. 2 types available, single pole changeover contacts. Miniature solder terminals.

Contact material Silver alloy
 Contact rating 2A 30V dc, 1A 250V ac
 Mechanical life >30x10⁴
 Electrical life >30x10⁴

	Button	Lever
Operating force	150g	80g
Release force min.	20g	5g
Pretravel max.	0.5mm	-
Overtravel min.	0.25mm	0.55mm
Movement diff. max	0.12mm	0.5mm
Actuator length	-	13mm

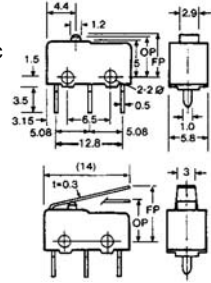

CODE	TYPE	PRICE
MMS450	Sub-Miniature Microswitch Button.....	£0.99
MMS460	Sub-Miniature Microswitch Lever.....	£0.99

MINIATURE MICROSWITCHES a range of V4 miniature single pole changeover microswitches, incorporating a long life stainless steel spring system and precious metal contacts. Rated 5A 250V ac.

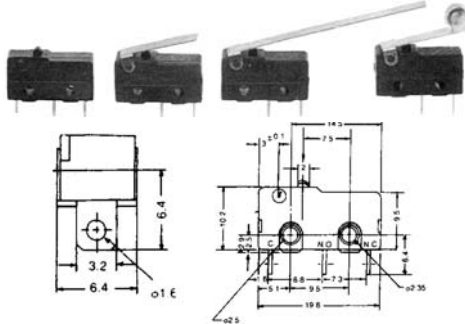

	Operating force	Pre-travel (max)	Overtravel (min)	Movement differential	Actuator length
Button	90g	0.6mm	0.5mm	0.1mm	-
Lever	42g	0.6mm	1.0mm	0.6mm	14.5mm
L/Lever	25g	4.7mm	1.0mm	1.8mm	43.0mm
Roller	42g	2.6mm	1.0mm	0.6mm	14.5mm

CODE	TYPE	PRICE
MSB470	Mini Microswitch Button.....	£0.90
MSL480	Mini Microswitch Lever.....	£0.95
MSL490	Mini Microswitch Long Lever.....	£1.10
MSR500	Mini Microswitch Roller Lever.....	£1.10

STANDARD MICROSWITCHES of high quality V3 standard size SPDT microswitches, offering a switching capacity of 10A 250V ac. Connections may be made by either a 1/4" connector or soldering.

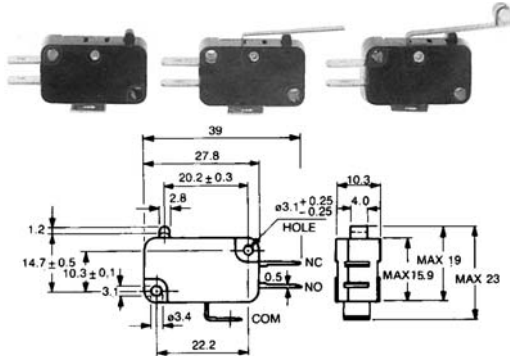

CODE	TYPE	Operating Force	PRICE
SMSB06	Standard Microswitch Button.....	285g.....	£0.99
SMSL15	Standard Microswitch Lever.....	130g.....	£0.99
SMSR45	Standard Microswitch Roller.....	140g.....	£1.25

V3 PADDLE LEVER MICROSWITCH A high quality V3 size microswitch rated at 3A 250V AC. The switch incorporates a wide and long paddle lever which is ideal for quick alignment in security and safety applications. Ideally suited for use as a tamper switch in alarm panels and bell boxes. Silver plated contacts. Camden CMNS 2830D.



Technical specification
 Rating 3A 250V AC
 Dielectric strength 1000V AC
 Mechanical life 500,000 operations min
 Lever dimensions 9 x 62mm
 Terminals Solder/Faston 6.35W x 10L x 0.8mm

CODE	TYPE	PRICE
820-326	Paddle Lever Microswitch	£1.69

EDGE SWITCHES

MINIATURE THUMBWHEEL EDGE SWITCH an ultraminiature, thumbwheel actuated edge switch that can be snapped together with others of the same type or with the available end cheeks to form a unit that will clip-fit into panels having a thickness of between 0.8 and 3.2mm. It is front mounting and matt black with white engraved legend and with 10 digit (0 - 9) BCD code output. Contacts are hard gold flash over nickel plate on phosphor bronze and termination is PCB terminal with pin holes. It has a long operating life and housing is thermoplastic/ olyacetal to UL 94HB. End cheeks available.



Technical Specification

Operating voltage: 50V AC/28V DC max.
 Switching current: 100mA max.
 Carrying current: 500mA max.
 Contact resistance: 200Ω max.
 Insulation resistance: 10Ω Between common terminal and any output
 1000Ω Between each output and non current carrying part
 Dielectric strength: 800V AC for 1 minute Between common terminal and any output
 1000V AC for 1 minute Between each output and non current carrying part

Operating temperature: -20°C to +70°C
 Operating force: 350g max.
 Mechanical life: 200,000 operations Electrical life: 100,000 operations
 Body height: 16mm Width (with end cheeks): 16mm Overall depth: 21mm

CODE	TYPE	PRICE
30-0060	Ultra Miniature Thumbwheel Edge Switch.....	£0.89

MINIATURE EDGE SWITCH a high quality matt black snap together push button operated edge switches with white engraved legends. With gold plated make-before-break contacts and two push switches for count up or count down functions. Switches and end cheeks clip together to clip-fit into panels from 0.8 to 3.2mm in thickness.



Technical Specification

Contact rating: 0.1A 50V AC/28V DC
 Switching current: 0.1A maximum
 Carry current: 1A maximum
 Materials - housing: Thermoplastic/polyacetal UL 94HB
 contacts: hard gold flash over nickel plated phosphor bronze
 Contact resistance: <200mΩ maximum
 Mechanical life: >2 x 10⁵ ops Operating temperature: -20°C to +65°C

CODE	TYPE	PRICE
30-0056	Miniature BCD Edge Switch.....	£3.99
30-0058	Miniature BCD Edge Switch Cheeks.....	£0.99

SQUIRES ELECTRONIC COMPONENTS

ULTRA MINIATURE THUMBWHEEL EDGE SWITCH a range of high quality matt black snap-together push switches with white engraved legends. With gold plated make-before-break contacts and two push switches for count up or count down functions. Switches and end cheeks are easily clipped together which in turn clip-fit into panels from 0.6 to 2mm in thickness.



Technical Specification

Switch rating: 0.1A 50V AC/DC
 Insulation resistance: 1000MΩ min.
 Mechanical life: 104 operations
 Operating temperature: -20° to +65°C
 Material: Polyacetal copolymer (POM)

CODE	TYPE	PRICE
30-0066	Ultra Miniature BCD Edge Switch.....	£3.79
30-0068	End Cheeks for 30-0068.....	£0.89

MINIATURE THUMBWHEEL EDGE SWITCH a miniature, thumb-wheel actuated edge switch that can be snapped together with others of the same type or with the available end cheeks to form a unit that will clip-fit into panels having a thickness of between 0.8 and 3.2mm. It is front mounting and matt black with white engraved legend and with 10 digit (0 - 9) BCD code output. Contacts are hard gold flash over nickel plate on phosphor bronze and termination is PCB terminal with pin holes. It has a long operating life and housing is thermoplastic/polyacetal to UL 94HB. End cheeks available.



Technical Specification

Operating voltage: 50V AC/28V DC max.
 Switching current: 100mA max.
 Carrying current: 1A max.
 Contact resistance: 200Ω max.
 Insulation resistance: 10Ω Between common terminal and any output
 1000Ω Between each output and non current carrying part
 Dielectric strength: 800V AC for 1 minute Between common terminal and any output
 1000V AC for 1 minute Between each output and non current carrying part
 Operating temperature: -20°C to +70°C
 Operating force: 350g max.
 Mechanical life: 200,000 operations
 Electrical life: 100,000 operations
 Body height: 22mm
 Width (with end cheeks): 14mm
 Overall depth: 34mm

CODE	TYPE	PRICE
30-0062	Miniature Thumbwheel Edge Switch.....	£3.39
30-0064	Mini Thumbwheel Edge Switch End Cheeks.....	£0.65

REED SWITCHES

REED SWITCH a low cost dry reed switch with rhodium plated contacts for long life. When a magnet or electromagnet is brought near the reed, magnetism is induced which causes the switch to close. When the operating magnet is removed, the springiness of the reed breaks the contact. Contact rating 0.5A ac or dc, switching voltage 200V dc or 125V c max. Glass length 27mm x 3.5mm.

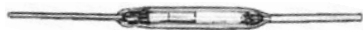

CODE	TYPE	PRICE
RES430	Reed Switch 10 Pack.....	£1.50
MPM120	Reed Switch Operating Magnets 10 Pack.....	£1.50

DRY CONTACT RHODIUM REED SWITCHES these low-cost, long-life glass sealed reed switches feature rhodium contacts. They have been designed to cover a wide range of demanding applications including: liquid level sensors, security systems, reed relays, proximity sensors, counting devices etc. Tested to one billion operations.



Technical Specification

	27-0050	27-0052	27-0054
Length:	20.3mm	14.2mm	12.7mm
Contact:	NO	NO	NO
Contact rating:	10VA	10VA	10VA
Switching current:	1A	1A	0.5A
Carry current:	1.5A	1.5A	1A
DC switching voltage:	100V	100V	100V
AC switching voltage:	150V rms	125V rms	100V rms
Breakdown voltage:	250V DC	250V DC	200V DC
Contact resistance:	100mΩ	100mΩ	150mΩ

CODE	TYPE	PRICE
27-0050	Dry Contact Reed Switch Standard.....	£1.69
27-0052	Dry Contact Reed Switch Miniature.....	£1.40
27-0054	Dry Contact Reed Switch Sub-Miniature.....	£1.40

REED SWITCHES a range of dry reed switches with rhodium plated contacts for long life. When a magnet or electromagnet is brought near the reed, magnetism is induced which causes the switch to close. When the operating magnet is removed, the springiness of the reed reverses the action. 8 types are available for a wide range of applications. Sold individually.

Case

code	A	B	C	D
1	36	10	2.0	0.4
1A	46	15	2.54	0.6
2	55	14	2.3	0.5
3	52	14	2.6	0.5
4	55	14	2.2	0.35
6	55	18.5	2.6	0.7
8	79	52	5.4	2.5



A = Overall length, B = Glass length
 C = Diameter, D = Lead diameter

Type	Case	Contact Rating VA Max	Switching Current A Max	Switching Voltage AC max	Switching Pull range (AT)	Code
Micro SPST	1	1.0	0.1	24	10-30	820-800
Sub SPST	2	10.0	0.5	100	15-35	820-805
Sub SPDT	3	3.0	0.2	30	15-30	820-810
Sub SPST	4	10.0	1.0	250	10-30	820-815
Mini SPST	1A	10.0	0.5	140	14-23	820-820
Mini SPST	6	40.0	2.0	440	14-23	820-825
Comp SPST	8	120.0	3.0	1500	75-95	820-835

CODE	TYPE	PRICE
820-800	Micro Reed Switch SPST.....	£1.55
820-805	Sub-miniature Reed Switch SPST.....	£1.05
820-810	Sub-miniature Reed Switch SPDT.....	£4.79
820-815	Sub-miniature Reed Switch SPST.....	£1.99
820-820	Miniature Reed Switch SPST.....	£1.35
820-825	Miniature Reed Switch SPST.....	£2.35
820-835	Compact Reed Switch SPST.....	£5.25

SEE ALSO

THE SENSORS SECTION

FOR MOVEMENT SENSORS AND SWITCHES

SQUIRES MODEL & CRAFT TOOLS

ENCAPSULATED REED SWITCHES a range of low cost reed switches which have been encapsulated in compact ABS housings enabling easy PCB mounting. With Rhodium contacts for low contact resistance and fully sealed to give maximum mechanical protection and minimise the ingress of dust and moisture, ideal for harsh environments.



Technical Specification

Order code	27-0072	27-0074	27-0076	27-0078	27-0080
Type	Normally open	Normally open	Normally open	Normally open	Changeover
Switching voltage (max.)	24V AC	140V AC	150V AC	470V AC	100V AC
Switching current (max.)	0.1A	0.5A	0.5A	0.5A	0.5A
Switching capacity (max.)	1VA	10VA	10VA	10VA	5VA
Contact resistance (max.)	200mΩ	120mΩ	150mΩ	150mΩ	150mΩ
Pitch (mm)	12	22	20	22	20
Dimensions (L x W x H) (mm)	15 x 3.2 x 3.2	25 x 3.7 x 3.7	23 x 4.2 x 4.2	25 x 3.7 x 3.7	

CODE	TYPE	PRICE
27-0072	Encapsulated Reed Switch PPS24.....	£2.70
27-0074	Encapsulated Reed Switch PPSRI-03A.....	£2.15
27-0076	PCB Reed Switch N/O.....	£1.70
27-0078	Encapsulated Reed Switch PPS470.....	£2.25
27-0080	PCB Reed Switch C/O.....	£3.45

MAGNETS

MAGNETS a range of disc magnets manufactured from Neodymium iron Boron which is up to 5 times more powerful than Alnico. All magnets are nickel plated to reduce the onset of corrosion when used under normal circumstances. Ideally suited to proximity switch triggering or biasing where space is at a premium.



Technical Specification

	Distance at which magnets measure		
	1000 gauss	Dims	Surface flux (gauss)
M1219-1	4.1mm	3 x 1mm	1500
M1219-2	2.2mm	3 x 2mm	2500
M1219-3	1.8mm	4 x 3mm	3200
M1219-4	1.2mm	6 x 2mm	2500
M1219-5	0.6mm	10 x 5mm	3500

Operating temperature 120°C max.

NB M1219-4 has north seeking identified with a dimple.

CODE	TYPE	PRICE
820-507	Magnet 3 x 1mm M1219-1.....	£0.79
820-509	Magnet 3 x 2mm M1219-2.....	£0.80
820-510	Magnet 4 x 3mm M1219-3.....	£0.89
820-512	Magnet 6 x 2mm M1219-4.....	£0.99
820-514	Magnet 10 x 5mm M1219-5.....	£1.39

MINIATURE OPERATING MAGNET a hermetically sealed proximity switch housed in a round profile polystyrene case. With a single pole changeover contact arrangement. Ideally suited to position sensing and safety systems and fitted with a flying lead of overall length 300mm.



CODE	TYPE	PRICE
27-0090	Operating Magnet.....	£1.29

MINIATURE MAGNETS a range of select miniature magnets suitable for use with above reed switches. Supplied individually.

Code	Length	Width	Depth
820-850	12.7 x	3.2 x	1.6mm
820-855	19.0 x	3.2 x	3.2mm
820-860	28.0 x	4.8 x	4.8mm
820-865	25.4 x	6.4 x	6.4mm



CODE	TYPE	PRICE
820-850	Miniature Magnet 12.7 x 3.2 x 1.6mm.....	£0.45
820-855	Miniature Magnet 19.0 x 3.2 x 3.2mm.....	£0.99
820-860	Miniature Magnet 28.0 x 4.8 x 4.8mm.....	£1.80
820-865	Miniature Magnet 25.4 x 6.4 x 6.4mm.....	£2.90

BELL PUSH SWITCHES

LOW VOLTAGE BELL PUSH WHITE a low profile bell push in white plastic. Use for low voltage/low current applications only.



CODE	TYPE	PRICE
820-017	Low Voltage Bell Push White.....	£1.39

LOW VOLTAGE BELL PUSH WHITE/BLACK a bell push in white and black plastic. Use for low voltage/low current applications only.



CODE	TYPE	PRICE
820-019	Low Voltage Bell Push White/Black.....	£1.79

LOW VOLTAGE ILLUMINATED BELL PUSH WHITE/BLACK an illuminated bell push in white and black plastic. Use for low voltage/low current applications only.



CODE	TYPE	PRICE
820-018	Low Voltage Illuminated Bell Push White/Black...	£1.99

MORTICE SWITCH

MORTICE SWITCH a small switch as used on cupboards etc to turn a light on when the door is opened and off when the door is closed again. The switch is normally recessed into the frame of the cupboard.



CODE	TYPE	PRICE
560-546	Mini Mortice Switch.....	£2.19

AUDIO SELECTOR SWITCHES

LOUDSPEAKER SELECTOR SWITCH a two way audio output selector switch used to enable the connection of two pairs of loudspeakers such that the user may select either or both sets of loudspeakers at will without the need to change the cable connections. Housed in a neatly styled box with dimensions 162 x 100 x 50mm. Controlled by a rocker switch.



CODE	TYPE	PRICE
800-180	Two Way Loudspeaker Connection Box.....	£4.99